

Article number: 07158406001

Description: Universal joint single 0.158.406.001
S=180 X= Bore with keyway

Measures

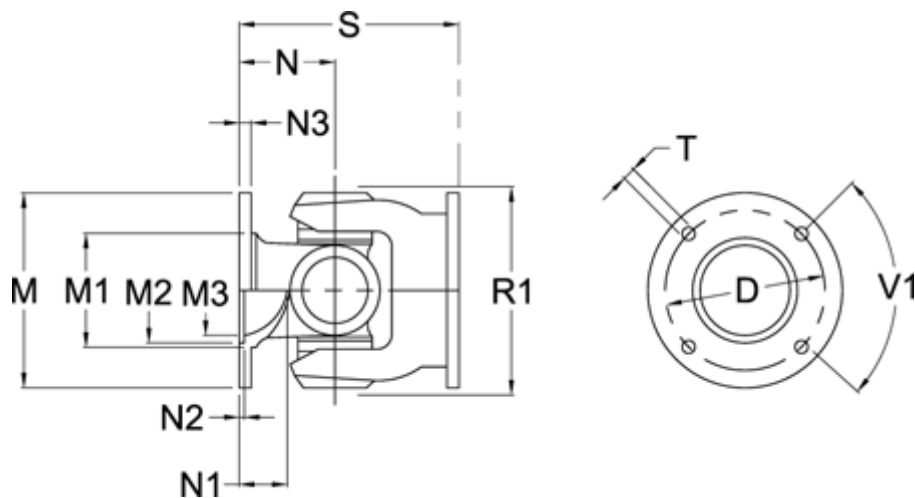

D	= 155,5 +/-0,1	N2	= 3,6 +/-0,5
Flange diameter M	= 180	N3	= 12
M1	= 126	Number of Flangeholes	= 8
M2	= 110	R1	= 150
M3	= 100	S min	= 180
Max. Bending Angle degrees	= 35	T	= 14 B12
N	= 90	V1 degrees	= 45
N1	= 25		